

Installation Instructions

IBM PC Music Feature

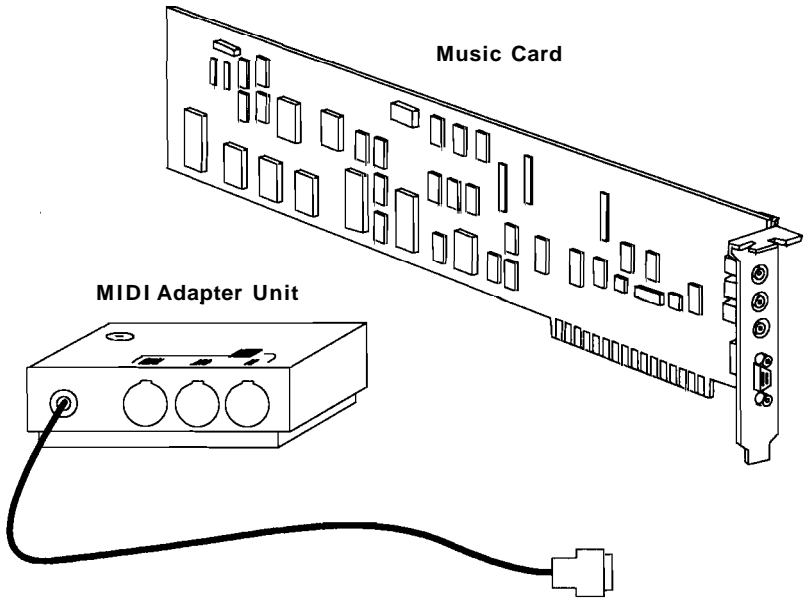

This carton contains the following:

- IBM PC music card
- Card support bracket
- MIDI adapter unit
- Installation instructions
- Diagnostics diskettes (3)

If any items are missing or damaged, notify your place of purchase.

84X0786

Statement of Limited Warranty for the 6011 IBM PC Music Feature

International Business Machines Corporation (IBM) gives you the following limited warranty for this Product only if it was originally purchased for use, not resale, from IBM, an IBM Authorized Dealer or any other IBM approved reseller for this Product (original purchase).

The Type of Warranty Service for this Product is **Customer Carry-In Repair**. The Warranty Period is **one year**, which starts on the date of original purchase (Date of Purchase) as shown on the receipt which establishes the proof of original purchase.

IBM warrants that on the Date of Purchase this Product will meet IBM's official published specifications which are available from IBM upon request. If, during the Warranty Period, this Product is found by IBM or an IBM Authorized Dealer to be 1) defective in material or workmanship or 2) otherwise not in good working order, IBM or such Dealer will remedy the problem by providing the Type of Warranty Service indicated above at no additional charge. Warranty service does not include repair or exchange when the problem results from accident, disaster, misuse, abuse, another machine, non-IBM modification, or service of the Product by other than IBM or an IBM Authorized Dealer for this Product.

To obtain warranty service, you must, during the Warranty Period, present this Product and the proof of original purchase to 1) an IBM Authorized Dealer for the Product or 2) IBM at an IBM Service/Exchange Center. Any transfer of the Product to another user during the Warranty Period should therefore include the proof of original purchase. You may ship the Product to an IBM Service/Exchange Center to obtain warranty service. If you do so, you must insure it or bear the risk of loss or damage in transit. In addition, you must prepay shipping charges and use the original shipping container or equivalent. Return shipping charges within the United States and Puerto Rico will be paid by IBM.

Note: If the Type of Warranty Service is **Customer Carry-In Repair**, it includes the return of the original Product to you. It may include the exchange of some parts or components.

If the Type of Warranty Service is **Customer Carry-In Exchange**, it includes the exchange of ownership of the Product between you and IBM or the IBM Authorized Dealer. Therefore, you must remove all non-IBM parts and all alterations and attachments, and you must also ensure that it is free from any outstanding liens.

Before presenting this Product for warranty service, you must remove all programs, data and removable storage media. Products and parts provided as a result of warranty service may be other than new but will be in good working order and become your property at the time of exchange. At the same time, the exchanged Products or parts become the property of IBM or the IBM Authorized Dealer.

If this Product is an optional feature, this limited warranty applies only when the feature is used in a machine for which it was designed, and, to obtain warranty service, you may be required to present the feature with an IBM machine for which it was designed.

If you have any question about your warranty, contact your IBM Authorized Dealer for this Product or call IBM at 1-800-428-2569.

(Continued on next page)

If you purchased this Product directly from IBM under an Agreement for Purchase of IBM Machines, the Date of Installation is considered to be the Date of Purchase for warranty purposes, and, to obtain warranty service from IBM, you need not present proof of original purchase. To obtain warranty service from an IBM Authorized Dealer for the Product, contact IBM for proof of the original purchase from IBM.

This limited warranty will apply only to a Product purchased and located in the United States or Puerto Rico.

ALL EXPRESS AND IMPLIED WARRANTIES FOR THIS PRODUCT, INCLUDING THE IMPLIED WARRANTIES OF MERCHANTABILITY AND FITNESS FOR A PARTICULAR PURPOSE, ARE LIMITED IN DURATION TO THE WARRANTY PERIOD, AND NO WARRANTIES, WHETHER EXPRESS OR IMPLIED, WILL APPLY AFTER THIS PERIOD.

Some states do not allow limitations on how long an implied warranty lasts, so the above limitations may not apply to you.

This warranty gives you specific legal rights, and you may also have other rights which vary from state to state.

LIMITATION OF REMEDIES: Your sole remedy under this Statement of Limited Warranty shall be IBM's or an IBM Authorized Dealer's performance of warranty service. For any claim concerning performance or nonperformance by IBM or an IBM Authorized Dealer under this Statement of Limited Warranty, or for any other claim directly related to this Product, you shall be entitled to recover actual damages up to the limits set forth in the following paragraph.

IBM's liability for damages to you for any cause whatsoever, arising out of this Statement of Limited Warranty, or for any other claim directly related to this Product, shall be limited to the greater of \$5000 or the amount paid for this Product at the time of original purchase. This limitation of liability will not apply to claims for personal injury or damage to real property or tangible personal property caused by IBM's negligence. In no event will IBM be liable to you for any damages caused by your failure to perform your responsibilities under this statement, or for any lost profits, lost savings or other incidental or consequential damages, even if IBM, an IBM Authorized Dealer or an IBM approved reseller for this Product has been advised of the possibility of such damages, or for any claim by you based on any third party claim.

Some states do not allow the exclusion or limitation of incidental or consequential damages, so the above limitation or exclusion may not apply to you.

Federal Communications Commission (FCC) Statement

Warning: This equipment has been certified to comply with the limits for a Class B computing device, pursuant to Subpart J of Part 15 of FCC rules. Only peripherals (computer input/output devices, terminals, printers, etc.) certified to comply with the Class B limits may be attached to this computer when this computer is operated in a residential environment. Operation with non-certified peripherals is likely to result in interference to radio and TV reception.

Instructions to User: This equipment generates and uses radio frequency energy and if not installed and used properly, that is, in strict accordance with the manufacturer's instructions, may cause interference to radio or television reception. It has been type tested and found to comply with the limits for a Class B computing device in accordance with the specifications in Subpart J of Part 15 of FCC rules, which are designed to provide reasonable protection against such interference in a residential installation. However, there is no guarantee that interference will not occur in a particular installation. If this equipment does cause interference to radio or television reception, which can be determined by turning the equipment off and on, the user is encouraged to try to correct the interference by one or more of the following measures:

- Reorient the receiving antenna.
- Relocate the computer with respect to the receiver.
- Move the computer away from the receiver.
- Plug the computer into a different outlet so that computer and receiver are on different branch circuits.

In many instances, shielded cables and connectors must be used for connection to peripherals. Proper IBM cables are available from authorized dealers. The manufacturer is not responsible for any radio or television interference caused by using other than the recommended cables or by unauthorized modifications to this equipment; it is the responsibility of the user to correct such interference.

If necessary, the user should consult the dealer or an experienced radio/television technician for additional suggestions. The user may find the following booklet prepared by the Federal Communications Commission helpful:

How to Identify and Resolve Radio-TV Interference Problems.

This booklet is available from the following:

FOB Public Contact Branch
Room 725
1919 M St. NW
Washington, DC 20554
Tele. (202) 634-1940

Consumer Assistance and Small Business Div.
Room 254
1919 M St. NW
Washington, DC 20554
Tele. (202) 632-7000

Contents

Installation Requirements	3
Tools Required	3
Installation Instructions	5
Preparing for Installation	5
Preparing the IBM PC Music Feature Card for Installation	9
Installing the IBM PC Music Feature Card in Your System	15
Installation Instructions for the PC and the XT	16
Connecting External Equipment	27
Connecting Headphones	28
Connecting Audio Equipment	29
Connecting MIDI Equipment	30
Testing the Installation	32

Notes:

Installation Requirements

The IBM PC Music Feature Card must be installed in the system unit.

Tools Required

- Medium-size, flat-blade screwdriver
- 3/16-inch nutdriver (optional)
- 1/4-inch nutdriver (optional)

Notes:

Installation Instructions

This section provides installation instructions for the IBM PC Music Feature. See your *Guide to Operations* for instructions specific to your system.

Preparing for Installation

- 1** Your music card package includes three diagnostics diskettes. Look at the diskette labels and select the diskette for your system. Discard the other two diskettes.
- 2** Compare the diagnostics diskette you kept in step 1 with the diagnostics diskette located in your system's *Guide to Operations*.
- 3** Discard the diagnostics diskette with the lowest version number (the version number is shown on the diskette label).
- 4** Follow these steps to determine the devices installed on your system using the diagnostics diskette you selected in step 3:
 - a** Insert the diagnostics diskette in drive A and turn on your system.
 - b** The information on your screen instructs you to select an option from the displayed screen list. Select 0 to check out your system by running diagnostic routines. Answer the questions appropriate for your system.

When the screen that lists your installed devices appears, place a check mark in the space provided beside each installed device.

Level 2 Devices:

- Enhanced Graphic Adapter
- PC Network Adapter
- 3278179 Emulation Adapter

Level 3 Devices:

- Alt Async Communications Adapter
- Alt BSC Communications Adapter
Alt PC Network Adapter
- Alt Serial/Parallel Adapter-Serial Port
Cluster Adapter(s)
- SDLC Communications Adapter

Level 4 Devices:

- Async Communications Adapter
BSC Communications Adapter
- Serial/Parallel Adapter-Serial Port
- SDLC Communications Adapter

Level 5 (PC or XT) Devices:

- Fixed Disk Drive

Level 6 (AT®)Devices:

- Alt Printer Adapter
- Alt Serial/Parallel Adapter-Parallel Port
- Fixed Disk and Diskette Drive Adapter

Level 6 Devices:

- Diskette Drive

Level 7 Devices:

- Cluster Adapter(s)
- Data Acquisition Adapter(s)
- GPIB Adapter(s)
- Monochrome and Printer Adapter
- Printer Adapter
- Serial/Parallel Adapter-Parallel Port

- 5** Complete the diagnostics routines to verify that your system is operational.
- 6** Remove the diagnostics diskette from the drive and place it in the back cover of your system's *Guide to Operations*.
- 7** Turn off the power to the system unit.
- 8** Turn off all power switches on external devices (printer, expansion unit, or other non-IBM devices).

Notes:

Preparing the IBM PC Music Feature Card for Installation

- 1 Remove the music card from the package and place it on a flat surface.

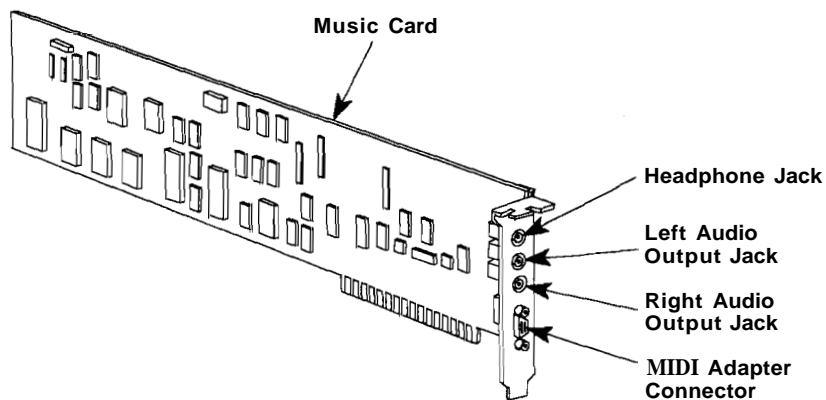

2

The music card is preset at level 3. However, it must be set in your system at a level not used by other devices. The following instructions help you determine if you need to change the level setting.

Warning: Failure to set the level correctly may result in damage to your hardware.

- Look at the list of installed devices that you checked in "Preparing for Installation" on page 5.

Note: If you have previously installed a music card in your system, check the level that was used for the first card and add it to the list of installed devices.

If your system does NOT have any of the level 3 devices, your music card is correctly set at level 3. Go to step 5 on page 13.

- If your system includes one or more of the level 3 devices, check levels 2 through 7 and identify the levels that do not have devices installed. Then go to step 3 to set the music card to one of those unused levels.
- If your system already contains adapters from each of the six groups, do not continue with the installation. Contact your IBM Authorized Dealer or your IBM Marketing Representative for assistance in selecting the appropriate levels for the cards in your system.

- 3 Use the illustration below to locate the six pairs of jumper pins on the music card. These pins are used to set the appropriate level for your card.

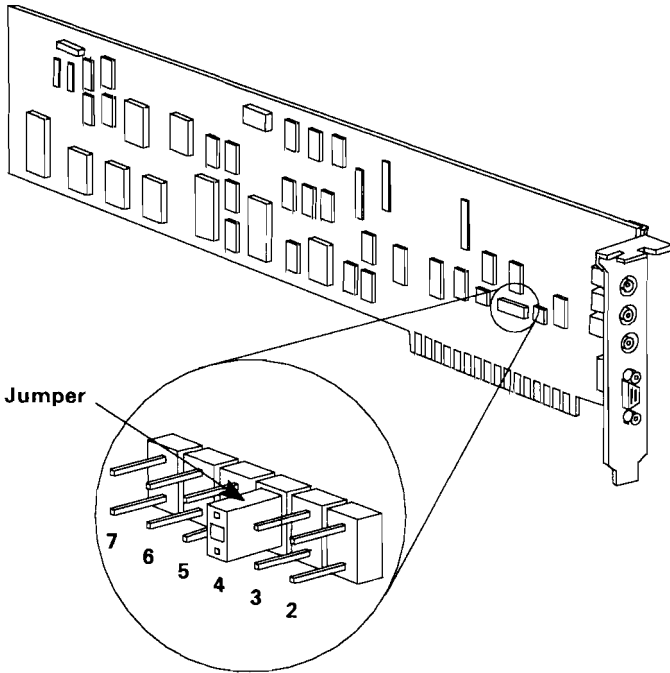

Jumper Installed On 4

- 4 If you need to change the level setting from level 3, remove the jumper by gently pulling it off the pins. Reinstall the jumper for the appropriate level by gently placing the jumper on the pins.

The following chart shows the correct jumper setting for each level.

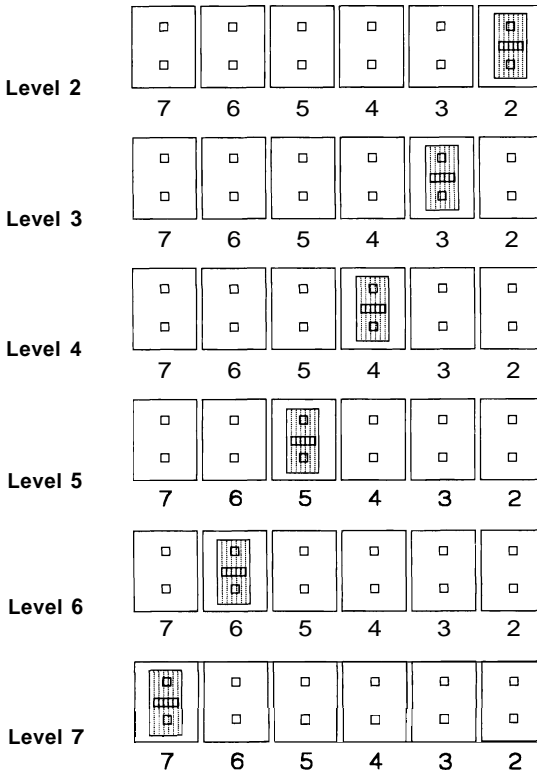

5 Locate the switch shown in the figure below.

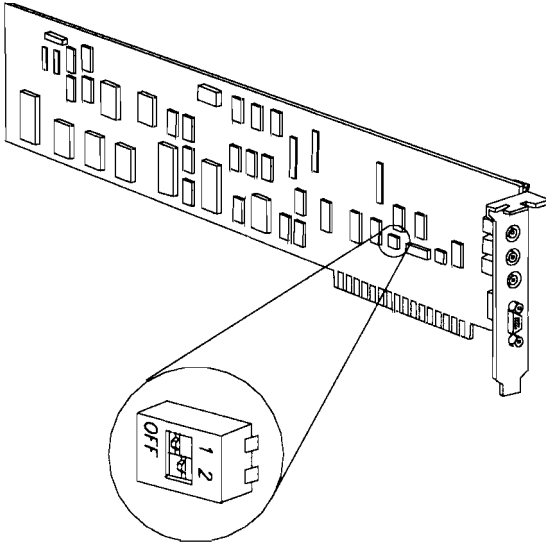

6

Use a ballpoint pen or another blunt-ended instrument to set the switches, if necessary.

If you are installing one music card, verify that the switches on the card are set as follows:

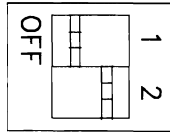

If you are installing a second music card, set the switches on the second card as follows:

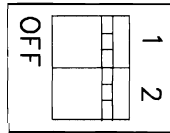

Installing the IBM PC Music Feature Card in Your System

- 1 Turn off all power to the system unit and all external devices.
- 2 Unplug the system unit and all other devices from the wall outlet.
- 3 If installed, unlock and remove the lock on your computer.

If you are installing the music card in an IBM Personal Computer or an IBM XT¹, see "Installation Instructions for the PC and the XT" on page 16. If you are installing the music card in another IBM computer, refer to your system documentation for cover removal and option installation instructions.

¹ Personal Computer XT and XT are trademarks of International Business Machines Corporation.

Installation Instructions for the PC and the XT

- 1 Disconnect all cables from the rear of the system unit.

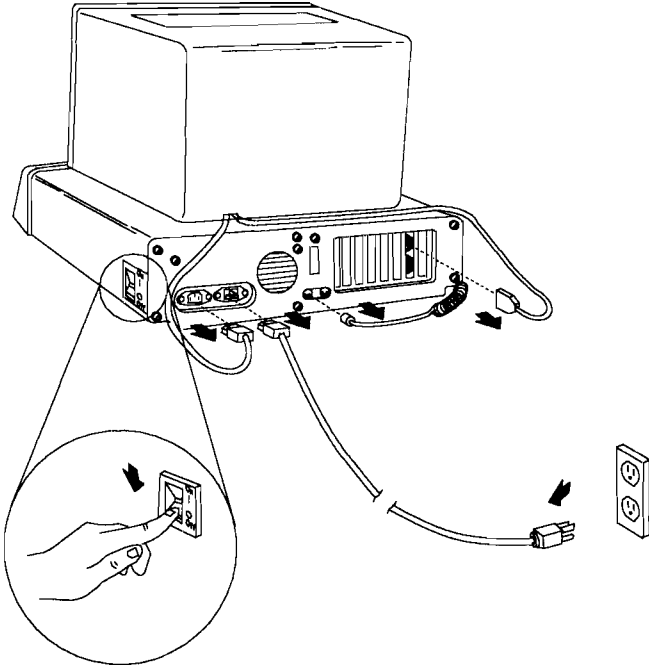

- 2 Move your keyboard and all disconnected devices away from the work area.
- 3 Move the system unit to allow access to the rear.
- 4 Use a flat-blade screwdriver or 1/4-inch nutdriver and remove the cover mounting screws by turning them counterclockwise as shown below. Save the screws for the reinstallation of the cover.

Cover Mounting Screws
(These screws may not be present on your unit)

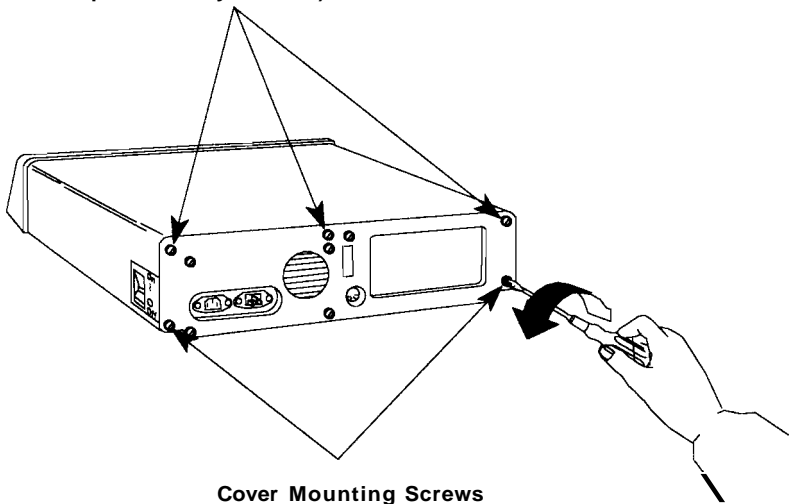

- 5 Carefully slide the unit's cover away from the rear and to the front, as shown in the figure below. When the cover will go no further, tilt it up, remove it from the base, and set it aside.

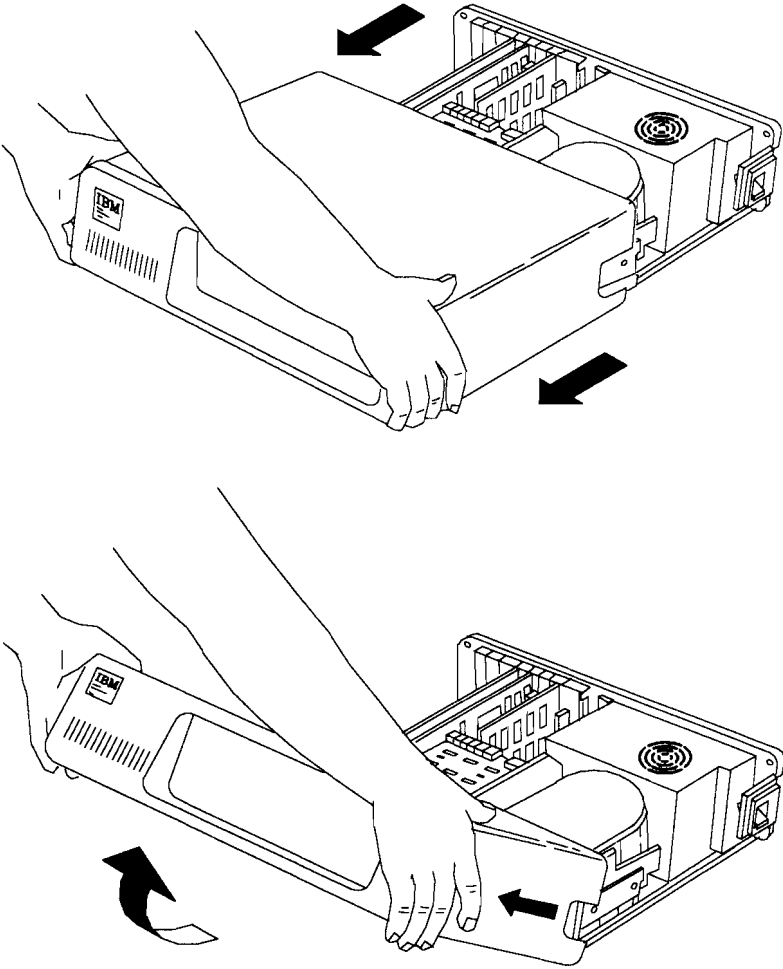

- 6 With the front of the unit toward you, look at the expansion slots inside the unit. The expansion slots are numbered from the left beginning with slot 1. If your unit has only five expansion slots, you can install the option in any unused slot. If your unit has eight expansion slots, you can install the option in any unused slot from 1 through 6.

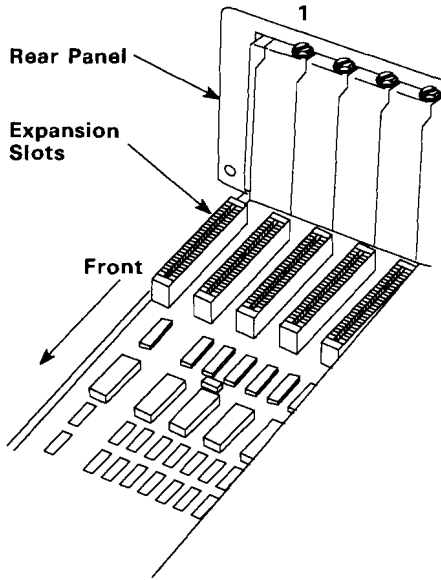

- 7 Use a flat-blade screwdriver or 3/16-inch nutdriver and remove the screw that holds the expansion-slot cover in place by turning the screw counterclockwise. Save the screw for installation of the option.

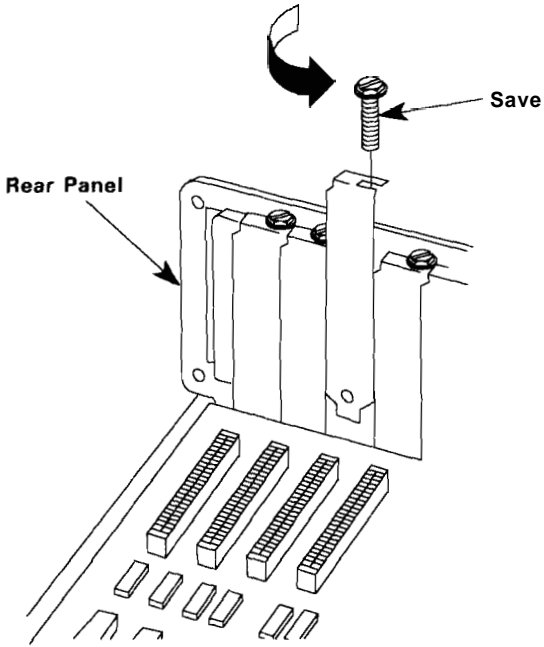

- 8 Locate the card support bracket that you received in your music card package. Position the card support bracket over the mounting holes that correspond to the empty expansion slot. Press firmly toward the front of the system to snap the bracket into place.

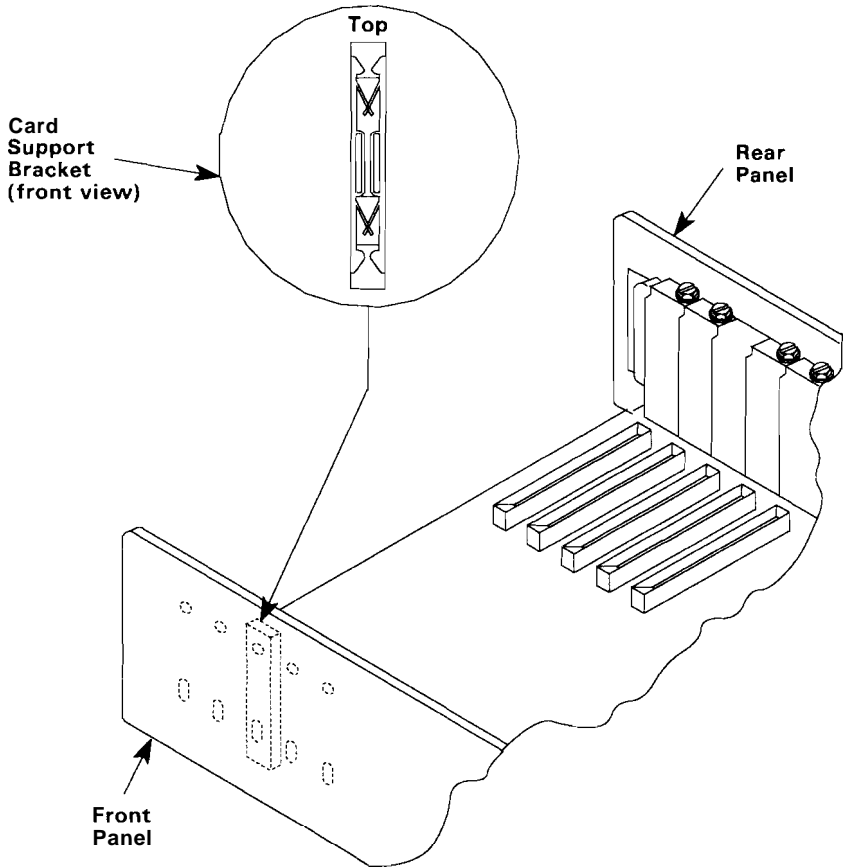

- 9 Hold the music card by the top and firmly press it into the expansion slot, as shown below. Be sure the card is firmly seated in the slot.

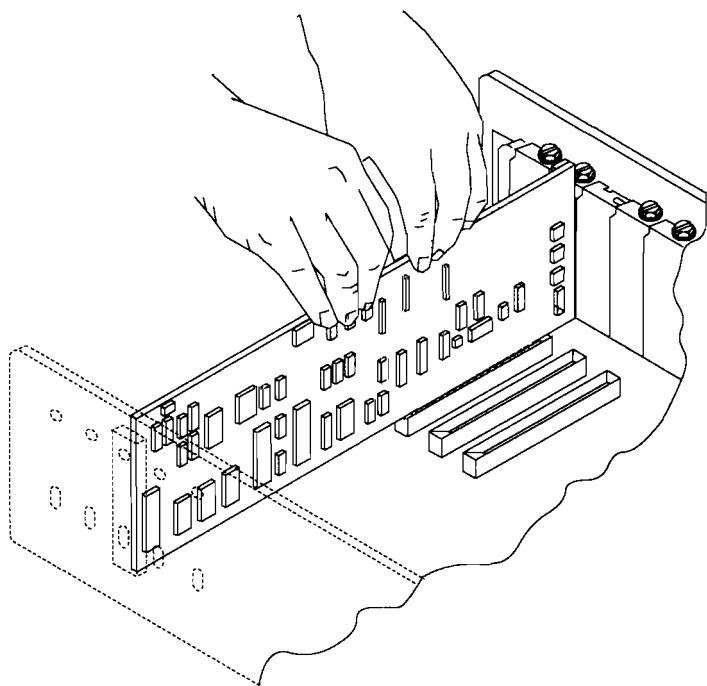

- 10 Align the slot in the option retaining bracket with the hole in the rear panel of the system unit. Start the screw clockwise, then tighten the screw with a flat-blade screwdriver or a 3/16-inch nutdriver.

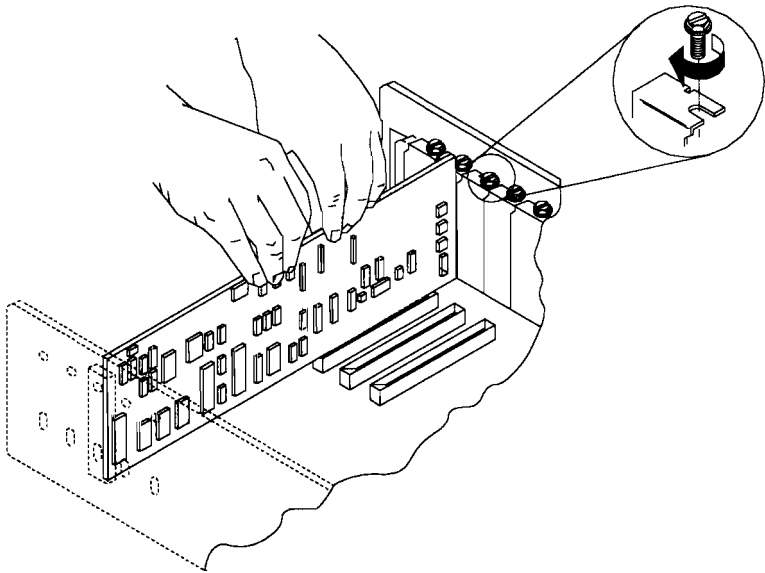
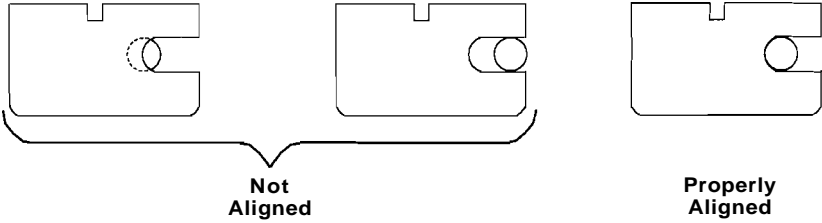

11 If you have any other options to install, do so before putting the unit's cover back on.

Put the unit's cover on by placing it as shown and carefully sliding it toward the rear of the unit.

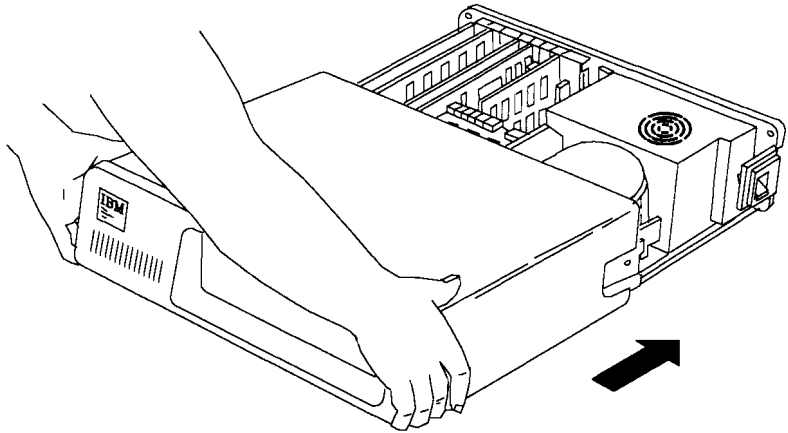
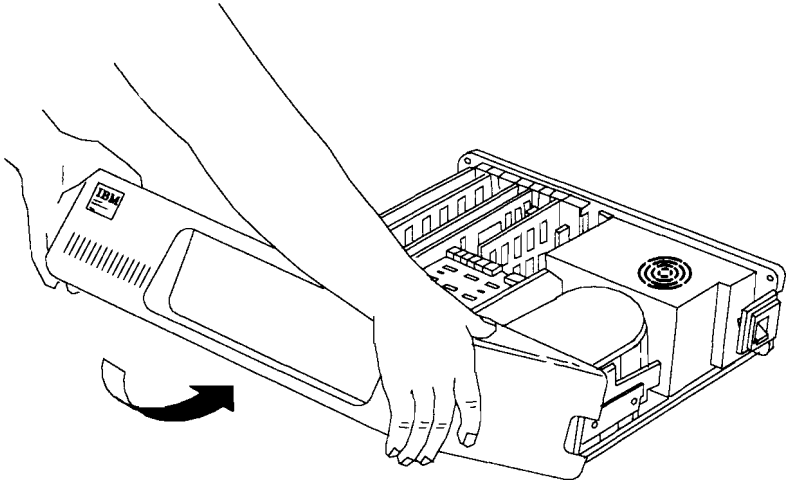

- 12 When the cover is all the way to the rear, align the screws with the threaded tabs and tighten the screws. Use a flat-blade screwdriver or 1/4-inch nutdriver and turn the screws clockwise.

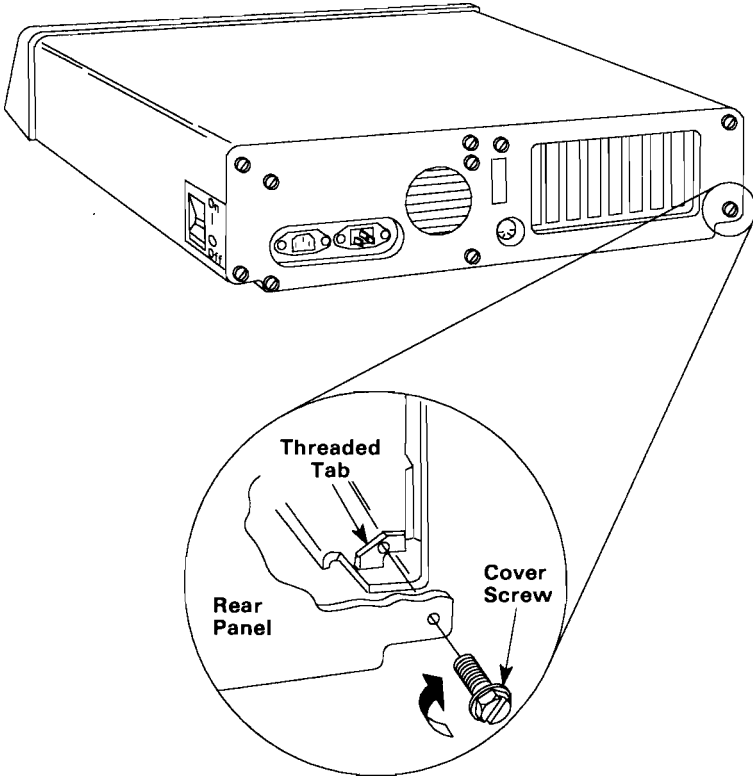

- 13 Make sure the power switches are turned OFF on the system unit and all external devices.
- 14 Reconnect all cables to your system unit.
- 15 Reconnect the system unit and all other devices to the wall outlet.

Connecting External Equipment

This section provides instructions on connecting the headphones, audio equipment, and Musical Instrument Digital Interface (MIDI) devices to the music card.

Connecting Headphones

You can listen privately to the output of the music card by connecting low-impedance (125-ohm) headphones with a 3.5 mm (1/8-inch) stereo miniplug. Insert the headphone plug into the headphone jack on the card.

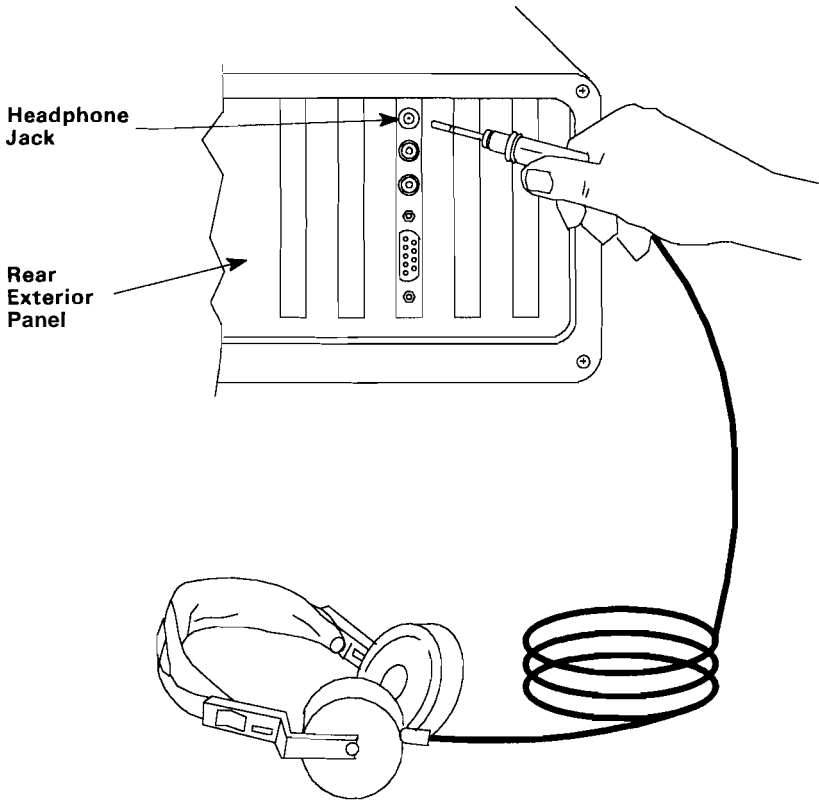

Connecting Audio Equipment

Your music card is equipped with stereo output terminals so that the card can be connected to a home-use audio system or portable stereo. Use audio cables that have an RCA phono plug on one end and the connector appropriate for your audio equipment on the other. Connections are made as follows:

- 1 Insert the phono cable plug into the appropriate output jack on the music card.
- 2 Connect the other end of the cable to the input terminal of your audio equipment.

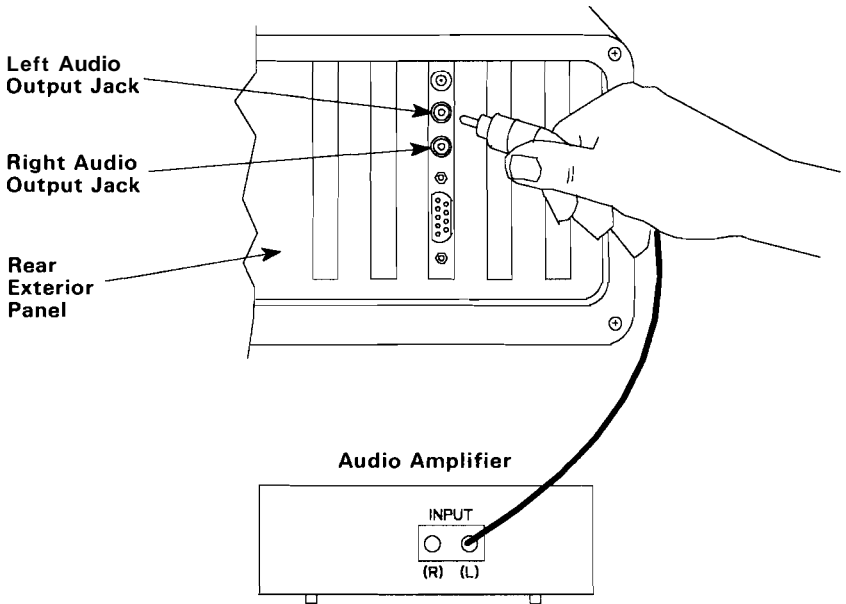

Warning: Due to the wide dynamic range and extended bass response of this card, **EXTREME CAUTION** should be used in selecting playback volume.

Connecting MIDI Equipment

You can connect MIDI equipment to the music card by using the MIDI adapter included in the music card package and MIDI cables. To install the adapter, insert the plug into the connector on the card and tighten the screws.

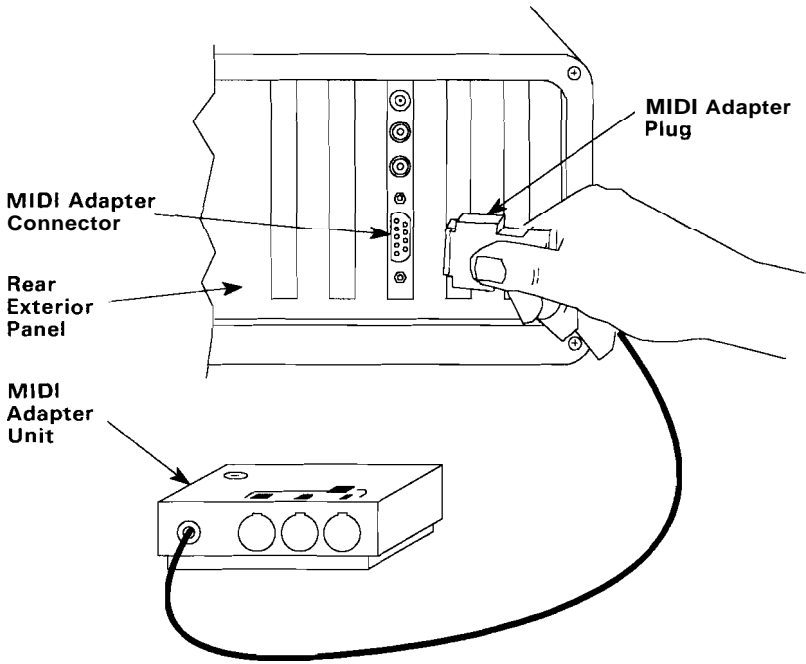

Note: The IBM PC Music Feature card sends and receives on MIDI channel 1 when powered on. The card can send or receive on any of the 16 available MIDI channels, with the appropriate software applications.

There are three MIDI terminals on the MIDI adapter. Each is connected as follows.

MIDI IN

External MIDI signals are input into the music card through the MIDI IN terminal. Connect one end of a MIDI cable to this terminal and the other end to the MIDI OUT terminal on your MIDI device.

MIDI THRU

MIDI IN signals are sent to the MIDI THRU terminal without alteration. To use the same MIDI signals on another piece of MIDI-compatible equipment:

- Connect one end of a MIDI cable to the MIDI THRU terminal
- Connect the other end of the MIDI cable to the MIDI IN terminal on the other device.

MIDI OUT

MIDI signals from the music card are output over the MIDI OUT terminal. Connect one end of a MIDI cable to the MIDI OUT terminal and the other end to the MIDI IN terminal of the MIDI device.

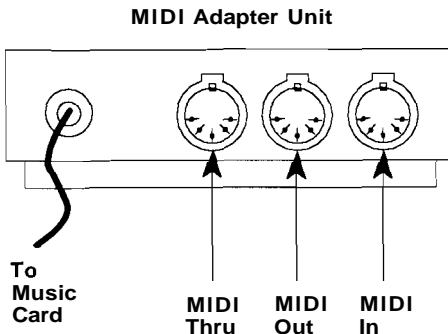

Testing the Installation

- 1 Insert the diagnostics diskette in drive **A**.
- 2 Run your system diagnostics to ensure that your music card was properly installed.

Notes:

Notes:

Notes:

